



iBoot
Web Enabled Power Switch
Ver 3.0



Table of Contents

Important Safety Instructions 2
General Description 3
General Description
Uses for iBoot
Multiple Control Options
Hardware Installation 4
Ethernet Connections
AC Power Connections
Initial Configuration 5
iBoot Setup Utility
Web Browser Operation 8
iBoot Setup 9
Device Settings
TCP/IP Settings
Auto-Ping
Power and System Passwords
Advanced Operation 12
Heartbeat Monitor
External Control Program
Direct TCP/Telnet Control
Specifications 15
Technical Support, Returns and Warranty 16



lboot_3.0_v070331d.doc

Important Safety Instructions

When using this product, basic safety precautions should always be followed to reduce the risk of fire, electric shock, and injury to persons, including the following:

1. Read and understand all instructions.
2. Follow all warnings and marked on the product.
3. Unplug this product from the wall outlet before cleaning. Do not use liquid cleaners or aerosol cleaners. Use a damp cloth for cleaning.
4. Do not use this product in an outdoor environment or near water, for example, near a bath tub, wash bowl, kitchen sink, or laundry tub, in a wet basement, or near a swimming pool.
5. Do not place this product on an unstable cart, stand, or table. The product may fall, causing serious damage to the product.
6. Slots and openings in this product and the back or bottom are provided for ventilation to protect it from overheating; these openings must not be blocked or covered. The openings should never be blocked by placing the product on the bed, sofa, rug, or other similar surface. This product should never be placed near or over a radiator or heat register. This product should not be placed in a built-in installation unless proper ventilation is provided.
7. This product should be operated only from the type of power source indicated on the marking label. If you are not sure of the type of power supply to your home, consult your dealer or local power company.
8. This product is equipped with a three wire grounding type plug, a plug having a third (grounding) pin. This plug will only fit into a grounding type power outlet. This is a safety feature. If you are unable to insert the plug into the outlet, contact your electrician to replace your obsolete outlet. Do not defeat the safety purpose of the grounding type plug. Do not use a 3-to-2 prong adapter at the receptacle; use of this type adapter may result in risk of electrical shock and/or damage to this product.
9. Do not allow anything to rest on the power cord. Do not locate this product where the cord will be abused by persons walking on it.
10. Do not overload wall outlets and extension cords as this can result in the risk of fire or electric shock.
11. Never push objects of any kind into this product through slots as they may touch dangerous voltage points or short out parts that could result in a risk of fire or electrical shock. Never spill liquid of any kind on the product.
12. To reduce the risk of electrical shock, do not disassemble this product, but take it to a qualified serviceman when some service or repair work is required. Opening or removing covers may expose you to dangerous voltages or other risks. Incorrect re-assembly can cause electric shock when the appliance is subsequently used.
13. Unplug this product from the wall outlet and refer servicing to qualified service personnel under the following conditions:
 - a) When the power supply cord or plug is damaged or frayed.
 - b) If liquid has been spilled into the product.
 - c) If the product has been exposed to rain or water.
 - d) If the product does not operate normally by following the operating instructions. Adjust only those controls that are covered by the operating instructions because improper adjustment of other controls may result in damage and will often require extensive work by a qualified technician to restore the product to normal operation.
 - e) If the product has been dropped or has been damaged.
 - f) If the product exhibits a distinct change in performance.
14. Avoid using a telephone (other than a cordless type) during an electrical storm. There may be a remote risk of electric shock from lightning.
15. Do not use the telephone to report a gas leak in the vicinity of the leak.
16. Do not exceed the maximum output rating of the auxiliary power receptacle.

Save These Instructions

General Description

The iBoot is a network attached, IP addressed, web controlled AC power switch. Anyone with a web browser can access iBoot to perform power On, Off or Power Cycle (Reboot or Power Burst). iBoot is password protected for security.

iBoot features international standard IEC320 connections and is compatible with power mains worldwide. Dual Ethernet jacks with built-in 10/100 switch make installation of iBoot easy.

Uses for iBoot

- Remote reboot of any device, routers, servers, kiosks, etc. The device to be rebooted need not be network attached.
- Secure sensitive devices by keeping them powered off when not in use. This prevents hackers from seeing them at all times.
- Power down equipment when not needed for power savings and to save on wear and tear.
- Power up alert devices like sirens, lamps, messages; or control environmental system like heaters, coolers pumps, etc.

Multiple Control Options

In addition to the Web control capabilities, iBoot features several other means to operate automatically or under computer control.

Auto-Ping: The Auto-Ping feature allows iBoot to automatically detect failed equipment and perform a timed reboot or other power control function (like turning on an indicator or siren). You set any IP address to be periodically pinged. When iBoot no longer detects a response from the address, the programmed power control function is actuated.

Heartbeat Monitor: Like the Auto-Ping in reverse, this feature uses a periodic message sent to the iBoot from a device. When that message is not received, the iBoot will perform the programmed power control function.

iBoot Control Program: Dataprobe offers an application to simplify operation of the iBoot. The iBoot Control Program operates one iBoot from a command line or window. It can be called by other programs to create an automated reboot system.

Direct TCP Control: iBoot can be controlled directly via messages sent via TCP. This feature allows programmers to add power control directly to their application and build automated scripts in any language to operate iBoot.

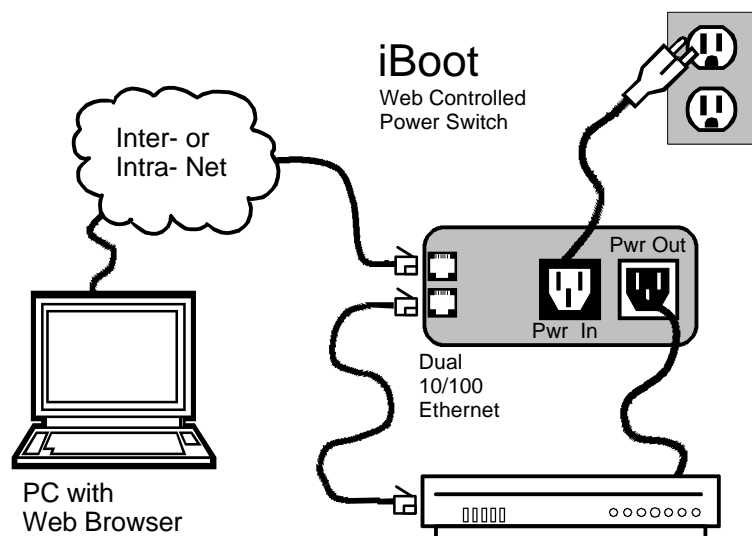

Hardware Installation

Ethernet Connections

iBoot supports 10/100 Ethernet using unshielded twisted pair (Cat 5) cabling. Two network jacks, with built-in Ethernet switch, are provided. They are auto-sensing for 10/100 and Uplink/Downlink. A Link LED for each jack indicates when the connection to the network is properly established. The built-in switch allows one cable from the wiring closet to be used for both iBoot and the device it is powering (or any other device). Use of both network jacks is optional.

Note: iBoot supports DHCP. If your network uses a DHCP server, it will automatically assign an IP address when iBoot is first powered up on the network. If you do not use DHCP there are several other methods of assigning an IP address. Please read the Initial Configuration section, page 5 for more details.

AC Power Connections

Connect the device to be powered ON and OFF to the IEC receptacle marked Switched Outlet. An IEC 320 to North American (NEMA 5-15) power cord is included for connecting the iBoot outlet to the device to be controlled.

If a cord with a different terminating receptacle is required, be sure it is properly rated and meets all the required local electrical standards. If the device to be powered uses an IEC320 receptacle and detachable power cord, an IEC to IEC extension cord can be used.

The iBoot can be connected to a power strip to allow simultaneous control of multiple devices.

Make sure that the combined load of all controlled devices does not exceed 12 Amps for 105-125VAC or 10 Amps for 210-240VAC.

An LED Indicator next to the Switched Outlet will be On to indicate that the power is On at that outlet. This LED will turn Off to indicate that the power is Off to the outlet.

Connect the supplied power cord to the connector labeled AC Input, and the other end to your AC source. If a power cord with a different terminating plug is required, be sure it is properly rated and meets all the required local electrical standards.

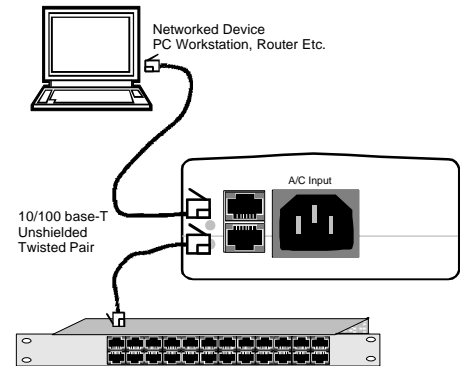

Connect Device to be Powered to iBoot

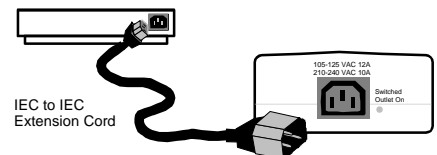
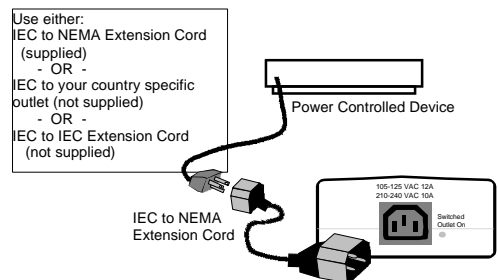

Connect to Power Source

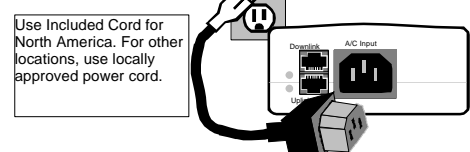

Initial Configuration

The iBoot Setup Utility supplied on the distribution CD provides the easiest means to find and configure your iBoots for use. It can discover all the iBoots on your network, display the current IP address of each, and allow setting of any valid IP address. The Setup Utility is available on the distribution CD or at <http://dataprobe.com/products/power/iBoot/iBootac/resources.html>

Install and run the iBoot Setup Utility:

1. Load the iBoot CD. (The CD supports only Windows)
2. Click on Setup.exe
3. Install the iBoot Setup Utility
4. Run the iBoot Setup Utility

Note: The IP address can only be set within the first two minutes of powering up the iBoot, and requires a power restart of the iBoot after setting the IP address. Make sure you have physical access to the iBoot before attempting to set the IP Address. The Setup Utility will only work with iBoots on the same local subnets as the iBoots.

Once the iBoot Setup Utility is run, click on Discovery to display all the iBoots on your network. New iBoots will display with the name Set Location and have either the factory default IP address of 192.168.1.254 or an IP address that was automatically assigned by the DHCP server on your network. If the IP address was assigned by a DHCP server, no changes to the IP Address are required.

The IP address field also indicates the IP port that is used by the iBoot. The standard port for web browser control is factory default Port 80.

Change the IP Address

1. Click on the row containing the iBoot to be set. The row will become highlighted.
2. Click on the Set IP Address button.
3. Enter the new IP Address into the form. Click OK when done.
4. A confirmation box is displayed. Click OK to clear the box.
5. Power cycle the iBoot to finish the process. A reminder of which iBoots that require this power down – power up procedure are indicated by a * .

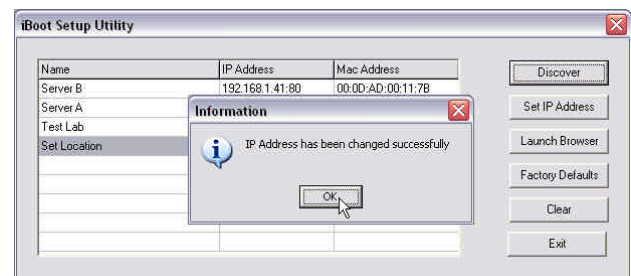
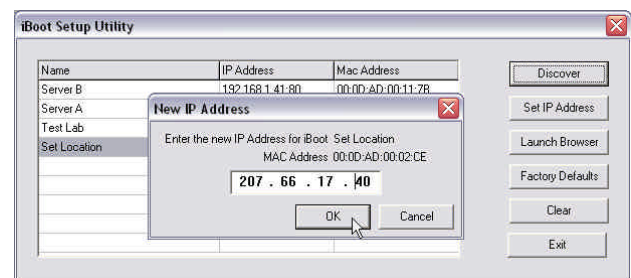
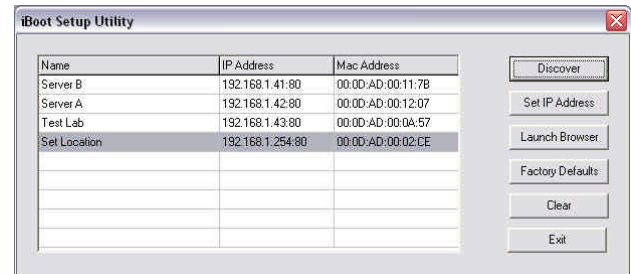

Once the IP Address is set and the iBoot is power cycled, other all other operational features of the iBoot can be set up. Click on Discover again to refresh the display, highlight the desired iBoot and click on Launch Browser. Follow the instructions on Page 9 to configure the iBoot.

The iBoot Setup Utility can also be used to return an iBoot to its Factory Default condition. This can be used to recover an iBoot with a lost password. Highlight an iBoot from the display and click Factory Defaults. This must also be done within the first two minutes of powering up the iBoot.

Other ways to set the IP Address

1. Automatically from a DHCP Server
2. Web Browser via the Set-up Page
3. ARP / Ping

iBoot comes with factory installed IP address 192.168.1.254 and ready to accept a new IP address from a DHCP Server. If you network has a DHCP server, it will automatically assign an IP address to iBoot the first time it is connected and powered up.

Setting the IP address from a DHCP Server

A DHCP server will automatically assign an IP address (dynamic address) as well as Subnet Mask and Gateway to the iBoot. If you power up iBoot without a fixed (static) IP address, the DHCP server will be able to assign an IP address. This is the factory default setting for iBoot. Once an IP address is assigned, you must check the DHCP server or use the iBoot Setup Utility to see what address is assigned to iBoot.

If you set the IP address using another method, the address becomes static. To return iBoot to dynamic addressing using DHCP, change the IP address, using the web browser to 0.0.0.0

Setting the IP address using Web Browser

To set the IP address using a Web Browser, connect the Ethernet connection to your local network and apply power to iBoot.

Open your browser and access iBoot by entering the default (192.168.1.254) or current IP address into your browser's Address window. Enter the password (the factory default is PASS). Click on Setup and follow the instructions on Page 9.

Setting the IP address using ARP / Ping

Notes: For security purposes, this may only be done within the first 2 minutes of powering up the iBoot. If the iBoot has received an IP address from a DHCP server, this technique will not work.

The ARP technique uses a PC running a command line (DOS Window) to set the IP Address. To set the IP address using ARP, connect the iBoot to your local network and apply power. The IP address to be assigned to iBoot must be use the same network segment as the computer assigning the address. ARP does not work across routed or switched networks.

To set the IP address using ARP, the hardware (MAC) address must be known. This address is located on the bottom of the unit. The syntax for the MAC address is: nn-nn-nn-nn-nn-nn

Windows (98 and Later)

1. Open a DOS window. (Run: Command)
2. Type the following command:
arp -s <IP Address> <MAC Address>
Where <IP Address> is the desired IP address (in dotted decimal) for the iBoot and the <MAC address> is the MAC Address of the iBoot. The MAC Address of the iBoot is located on bottom of the unit.

Example: arp -s 63.211.86.165 00-50-c2-05-01-c1 <enter>
 |new IP addr| |---MAC addr---|

3. Ping the iBoot to program the IP address into the iBoot.
Type: ping <IP Address>
Note: If the ping command returns "host not responding" 4 times then the address has not been programmed properly. The process must be run within two minutes of powering up the iBoot, and not have been set by a DHCP server. Check the IP or MAC Address. Repeat step 2. If the problem persists, contact the Dataprobe Tech Support.
4. Delete the entry from the ARP cache by typing:
arp -d <IP Address>
5. Ping the iBoot to confirm that it has been programmed.
If the iBoot fails to respond, repeat steps 2-4 above. If the problem persists, contact the Dataprobe support hotline.

Unix, Linux, MAC and others

Consult your systems administrator for information on other means of setting an IP Address. The unit should be pinged after the IP Address has been set to confirm proper operation.

Web Browser Operation

Password Protection

iBoot uses two passwords, one for normal power control use and one that also provides access to the setup functions. From the factory, both passwords are the same. (PASS)

Open your browser and enter the IP address of iBoot into the address bar. If you have changed the IP address by any of the methods described, enter that address, otherwise, use the default IP address 192.168.1.254



Enter the default password PASS or your password if it has been changed. A Username is not required. When the proper password is received the Control and Status Page is displayed.

Control and Status Page

Once the password is entered, the following page is displayed. (Only one person can be connected to the iBoot at a time.)

To control the power, click on the appropriate button. During power cycling, the Power Status bar will indicate the temporary status, with a blue background. Once the cycle is complete, the status bar will revert to its original condition. To abort a power cycle, click on either Power On or Power Off buttons. iBoot will assume the status selected.

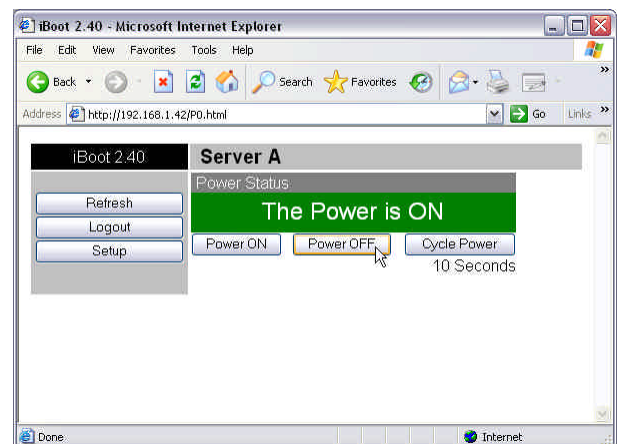

If the Auto-Ping or Heartbeat Features are in use then the page will also display the current status, OK or Triggered, for each, with a counter of how many times that feature was triggered. If connecting with the System Password, a reset button for the counter is provided.

Use the Refresh button to obtain the latest status of iBoot. Using your browser's refresh button can lead to inadvertent power switching.

To access the Setup page, the System Password must be used for the initial login. The factory default for the System Password, as well as the operation password is PASS. Both passwords can be changed in Setup.

When you are finished with iBoot, click on Logout. A confirmation page will be displayed. If you close your browser window without first clicking Logout, there will be a two minute delay before you can re-access iBoot.

iBoot uses an inactivity timer for security. When there is no activity for 2 minutes, the user is logged out and the password will need to be entered again for access. This is to prevent accidental lockout by leaving the user logged in.

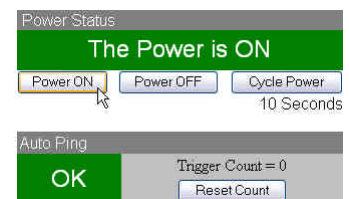

iBoot Setup

iBoot setup section consists of several pages. Access any page via the buttons on the left of the page. Each time a setting is changed click on the Apply button for that page to save the changes in iBoot.

Device Settings

Device Name: Set a 20 Character name to be displayed on the top of the Home page. This assists in identifying which iBoot is being accessed.

Cycle Time: 0 to 999 seconds power cycle time. This is the length of time the power will be off during a reboot, or on during a power burst.

TCP/IP Settings

IP address: Enter either a new IP address, or address 0.0.0.0 to enable addressing via DHCP.

Subnet Mask: Enter the Subnet Mask. This will be automatically set if using DHCP

Gateway: Enter the Gateway. This will be automatically set if using DHCP

HTTP Port: This setting is used to allow access to iBoot on a port other than the Web standard Port 80. If the port is changed, you will need to identify the port number when you enter iBoot's IP address into your browser. If the new port is 9105 then use address <http://192.168.1.254:9105>.

CallerIP 1 and 2: CallerIP provides IP address filtering to insure only authorized personnel access the iBoot. You can set two IP addresses or subnets that have authorization to access iBoot. If CallerIP 1 set is 0.0.0.0 or blank, no address filtering will be used. To authorize an entire subdomain, set the CallerIP to xxx.xxx.xxx.255 (where xxx.xxx.xxx is the subdomain you wish to authorize).

If AutoPing is used, any CallerIP settings must include the address to be pinged, or no response will be received by iBoot.

Take caution when setting the CallerIP as this will limit your access to iBoot. The only way to recover from being locked out by CallerIP is to power down iBoot and access it within the first two minutes of powering iBoot back up. CallerIP is ignored within the first two minutes of powering up the iBoot to allow this time to recover.

Note: *All of the TCP/IP Settings require a reboot of the iBoot, After clicking Apply, also click the Reboot button that will appear at the top of the page. The new settings will not take effect until the unit is rebooted. Upon Clicking Reboot, a page indicates the new URL for the device.*

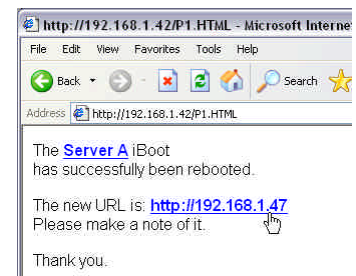
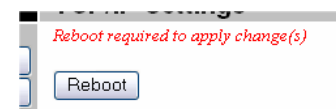
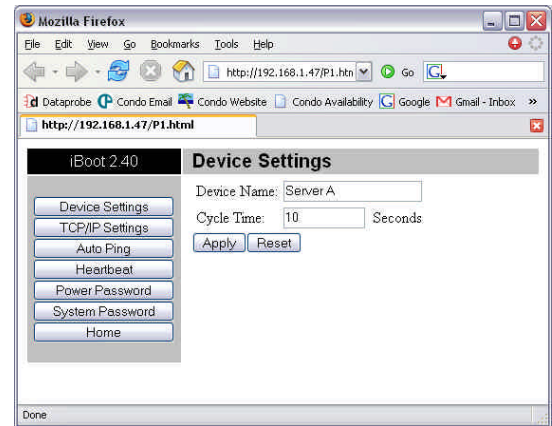

Auto Ping

The AutoPing feature allows iBoot to automatically detect failed equipment and perform a timed reboot or other power control function (like turning on an indicator or siren). You set any IP address to be periodically pinged. When iBoot no longer detects a response from the address, the programmed power control function is actuated.

Use Auto-Ping Locally: Put iBoot next to the device to be monitored and reboot it automatically when it no longer responds.

Use Auto-Ping Remotely: Put iBoot at a central facility to monitor a remote system and power up an alert when the remote device no longer responds.

Ping Address: Enter the IP address of the device to be pinged. If using CallerIP, this address must be allowed.

Ping Frequency: Enter 1 to 999 seconds. The ping will go out to the selected device this often.

Fail Counter: Enter 1-99 times the ping needs to fail consecutively before the selected action is taken. When the fail count has been reached, the AutoPing action will be triggered.

Action: Select from

None	AutoPing not used
Power On – Latch	Upon triggering, iBoot will power on and remain so until changed via the web, ibootctl.exe or direct messaging.
Power On – Follow	Upon triggering, iBoot will power on. When the ping response returns, iBoot will power off.
Power Off – Latch	Upon triggering, iBoot will power off and remain so until changed via the web, ibootctl.exe or direct TCP/IP control.
Power Off – Follow	Upon triggering, iBoot will power off. When the ping response returns, iBoot will power on.
Power Cycle	Upon triggering, iBoot will cycle the power. iBoot will wait the Ping Frequency x Fail Count; if the response does not return, the power will be recycled again. This will continue until the ping response returns or Auto Ping is turned off. Make sure your Auto Ping frequency is longer than the time required to reboot your device.
Power Cycle Once	Upon triggering, iBoot will cycle power one time. It will not cycle again automatically until the ping response returns and is lost again.

With Auto-Ping operational, the main iBoot page will display the current status of this feature. The status will be OK to indicate that iBoot is receiving responses to the ping, or that the fail counter has not yet been exceeded.

If the fail count has been exceeded, the status will change to Triggered. The Trigger Counter indicates the number of times the Auto-Ping feature has been triggered. A counter reset button is provided when logging in with the System password.

Heartbeat Monitor

See Advanced Operation for Heartbeat Monitor Setup

Power and System Passwords

Two passwords are used by iBoot. The Power Password allows access to the control of iBoot, but not to the Setup functions. When this password is used, the main screen will not have a link to Setup. The System Password allows access to both the Main Screen and the Setup Screen. The default for both Passwords is PASS. Passwords can be up to 10 characters long and are case sensitive.

Enter the current password then the new password twice to confirm. Click Apply for each password being changed.

Advanced Operation

Heartbeat Monitor

Like AutoPing, the Heartbeat monitor allows iBoot to monitor an external device and take action when this device fails. With the Heartbeat monitor enabled, iBoot will expect a network message on a regular interval. When it misses a user defined number of intervals, it will perform its programmed action.

Use the heartbeat to insure that you server is running. When the server crashes, it will be automatically rebooted.

The heartbeat can be generated in any of several ways;

- A Windows executable program that will run as a tray applet that will transmit heartbeats at a steady interval to an iBoot.
- A Windows .dll file is also available for use by Windows™ applications.

The Heartbeat Protocol will allow developers to imbed this capability directly into their software products.

All heartbeat tools are available on the distribution disk or at <http://dataprobe.com/products/power/iboot/ibootac/resources.html>

Heartbeat Setup Page

Frequency: Enter 1 to 999 seconds. If the heartbeat is not received within this time it will increment the counter.

Fail Counter: Enter the number of times (1-99) the heartbeat needs to fail before the selected action is taken. When the fail counter is reached, the heartbeat action will be triggered.

Port: Enter a port number to be used by the iBoot to look for the heartbeat. The default port is 9100.

Example:

Kiosk generates heartbeat at a regular interval to inform iBoot that operations are normal. When kiosk crashes, heartbeat stops and iBoot automatically reboots the kiosk

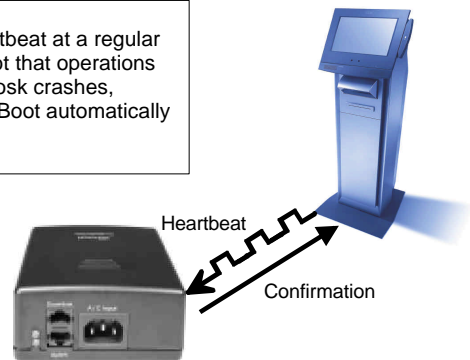

Action: select from

None	Heartbeat not used
Power On – Latch	Upon triggering, iBoot will power on and remain so until changed via the web, ibootctl.exe or direct messaging.
Power On – Follow	Upon triggering, iBoot will power on. When the heartbeat returns, iBoot will power off.
Power Off – Latch	Upon triggering, iBoot will power off and remain so until changed via the web, ibootctl.exe or direct messaging.
Power Off – Follow	Upon triggering, iBoot will power off. When the heartbeat response returns, iBoot will power on.
Power Cycle	Upon triggering, iBoot will cycle the power. iBoot will wait the Heartbeat Frequency x Fail Count; if the heartbeat does not return, the power will be recycled again. This will continue until the heartbeat returns or Heartbeat is turned off. Make sure your Heartbeat frequency is longer than the time required to reboot your device.
Power Cycle Once	Upon triggering, iBoot will cycle power one time. It will not cycle again automatically until the heartbeat returns and is lost again.

Using Heartbeat Monitor

With Heartbeat operational, the main iBoot page will display the current status of this feature. The status will be OK to indicate that iBoot is receiving heartbeats, or that the fail counter has not yet been exceeded.

If the fail count has been exceeded, the status will change to Triggered. The Trigger Counter indicates the number of times the Heartbeat feature has been triggered. A counter reset button is provided when logging in with the System password.

Using the Heartbeat Program

The heartbeat program and instructions are available from the distribution disk, or <http://dataprobe.com/products/power/iboot/ibootac/resources.html>

External Control Program

Dataprobe provides a remote control program to control iBoot directly. This program is useful for creating simple desktop icons for specific power functions for one or more iBoots. It can also be run from a command line and can be called by other programs. (Batch files etc.)

For example, ibootctl.exe can be called from server monitoring programs such as WhatsUp Gold™, Servers Alive™ or any program that provides for an external program to be run upon loss of a server.

ibootctl.exe is available on the distribution disk, or at <http://dataprobe.com/products/power/iboot/ibootac/resources.html>

Direct TCP/Telnet Control

For application developers, iBoot also supports control via direct TCP communications. To control iBoot in this manner requires opening a socket to iBoot and sending specific commands. Dataprobe can provide Perl scripts and other programmer resources to assist in integration of iBoot into any system.

The iBoot uses the TCP (Transport Communication Protocol) to communicate with the client system. To communicate with iBoot, establish a TCP connection using the Port as assigned in iBoot Setup. Once connected use the Send() function to send the commands to the iBoot and the Recv() function to receive the response. After sending a response iBoot will close the connection. The following outlines the commands and their responses.

Command Format

All of iBoot's commands follow the following format: **<esc><password><esc><action><cr>**

<esc>	ASCII Escape character. 1b hex or 27 decimal
<password>	The 1 to 10 character Power Control (not Setup) Password.
<action>	The following actions are valid for iBoot. These actions are case sensitive:
n	Turn Power ON
f	Turn Power OFF
c	Cycle Power. Cycle time is determined by Setup
q	Query.
<cr>	ASCII Carriage Return character. 0d hex or 13 decimal (/r)

Response Format

iBoot will return the following command with one of the following

ON	Power is ON
OFF	Power is OFF
CYCLE	Cycle Command Received
BUSY	iBoot is being controlled by another device

Specifications

Physical

Height	2.25 in.
Width	4.50 in.
Depth	6.00 in.
Weight	1.25 lb.
MTBF	160,100 hrs
Temperature	0 to 40 Deg. C

AC

Input	3 Prong, Male, IEC 320 input connector.
Input Cord	16AWGX3C 10A 250 UL/CSA/VDE Rated (1.25mm2X3C)
Voltage Range	Auto Sensing 105-240 VAC
Switched Receptacle	3 Prong Female IEC
Capacity	12 A Max at 105-125 VAC, 10 A Max at 210-240 VAC

Compliance

UL/cUL	UL60950 Listed I.T.E File No. E225914
CE	Directives 89/336/EEC, 92/31/EEC and 93/68/EEC EN 60950: 3rd Edition EN 55022: 1998 Class B
FCC	Part 15 Class B



Network

Dual 10/100 Unshielded Twisted Pair Ethernet Jacks.
Dual Jack Hub Built-in - Auto sensing
IP Addressed, DHCP assigned or Static
Internal HTTP Web Server
Forms Processing Browser required

User Settings

Record your Setup here for reference

Location		Notes:
MAC Address		
IP Address		
Subnet Mask		
Gateway		
HTTP Port		
Auto-Ping Address		
Auto-Ping Port		
Heartbeat Port		

Technical Support, Returns and Warranty

Dataprobe Technical Support is available 8:30AM to 5:30PM ET to assist you in the installation and operation of this product. To obtain Technical Support call 201- 934-5111, or Email us at tech@dataprobe.com. Please have the following information available when you call:

- Model of Product
- Lot and Version Numbers
- Data of Purchase
- Name of Seller (if other than Dataprobe)

If you purchased this product through an Authorized Dataprobe Reseller, you should contact them first, as they may have information about the application that can more quickly answer your questions.

WARRANTY

Seller warrants this product, if used in accordance with all applicable instructions, to be free from original defects in material and workmanship for a period of One Year from the date of initial purchase. If the product should prove defective within that period, Seller will repair or replace the product, at its sole discretion.

Service under this Warranty is obtained by shipping the product (with all charges prepaid) to an authorized service center. Seller will pay return shipping charges. Call Dataprobe Technical Service at (201) 934-5111 to receive a Return Materials Authorization (RMA) Number prior to sending any equipment back for repair. Include all cables, power supplies and proof of purchase with shipment.

THIS WARRANTY DOES NOT APPLY TO NORMAL WEAR OR TO DAMAGE RESULTING FROM ACCIDENT, MISUSE, ABUSE OR NEGLIGENCE. SELLER MAKES NO EXPRESS WARRANTIES OTHER THAN THE WARRANTY EXPRESSLY SET FORTH HEREIN. EXCEPT TO THE EXTENT PROHIBITED BY LAW, ALL IMPLIED WARRANTIES, INCLUDING ALL WARRANTIES OF MERCHANTABILITY OR FITNESS FOR ANY PURPOSE ARE LIMITED TO THE WARRANTY PERIOD SET FORTH ABOVE; AND THIS WARRANTY EXPRESSLY EXCLUDES ALL INCIDENTAL AND CONSEQUENTIAL DAMAGES.

Some states do not allow limitations on how long an implied warranty lasts, and some states do not allow the exclusion or limitation of incidental or consequential damages, so the above limitations or exclusions may not apply to you. This warranty gives you specific legal rights, and you may have other rights which vary from jurisdictions to jurisdiction.

WARNING: The individual user should take care to determine prior to use whether this device is suitable, adequate or safe for the use intended. Since individual applications are subject to great variation, the manufacturer makes no representation or warranty as to the suitability of fitness for any specific application.

Dataprobe Inc.